

Datasheet: LU50

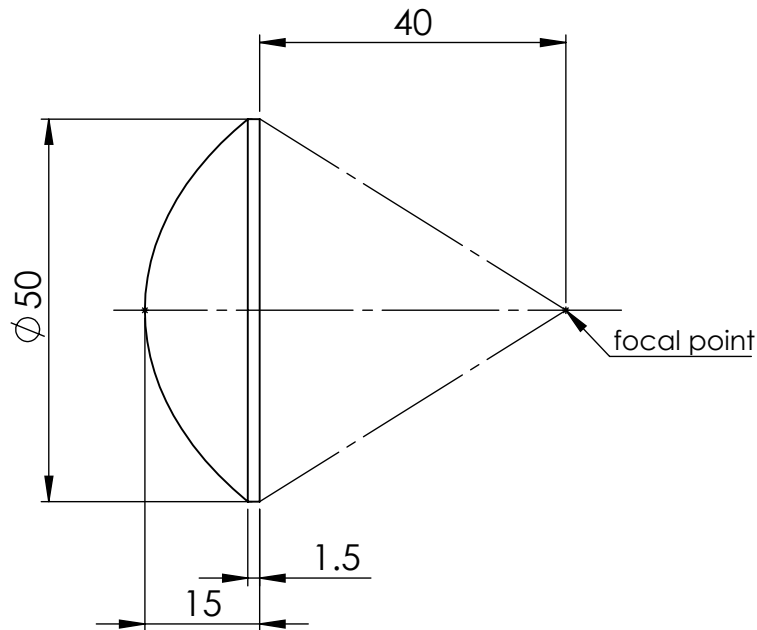

Specifications

Material	UHMWPE
Diameter D	50 mm
Thickness d	15 mm
Effective Focal Length EFL	50 mm
Back Focal Length BFL	40 mm
Refractive Index n (at 1THz)	1.52
Focal Spot (FWHM at 1THz)	0.9 mm
Transmission (at 1THz)	90* %

* The transmission of this lens is limited by Fresnel loss.

Focal Spot Size

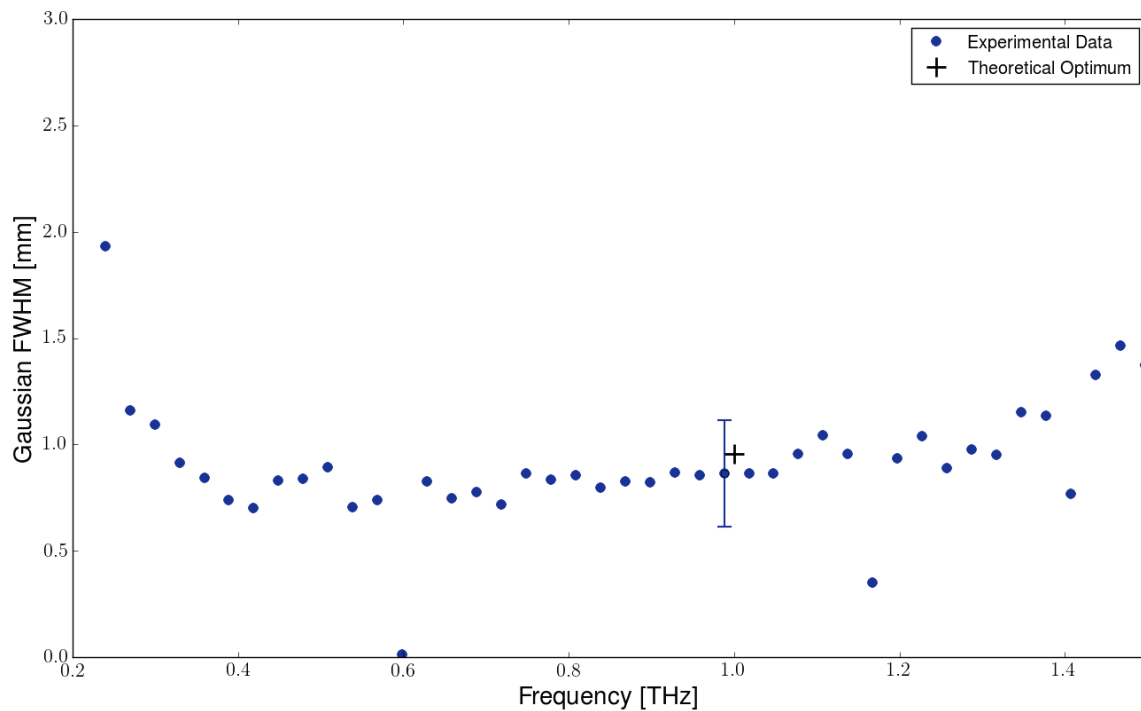

The above figure shows the Gaussian FWHM of the focus spot plotted against the frequency. The beam profiles were recorded with the knife edge method in a Terahertz Time Domain Spectroscopy (THz-TDS) instrument.

To calculate the FWHM of the spots for different frequencies, a Gaussian beam shape was assumed. The collimated input beam had a FWHM of 10mm at 1THz. The cross in the figure above indicates the corresponding theoretical FWHM which was found to be 0.95mm at 1THz using the formula below. The error bar is given by the step size of the knife-edge (0.25mm) and serves as an indicator of the measurement accuracy.

$$FWHM_{spot}(\nu) = \frac{4}{\pi} \frac{fc/\nu}{FWHM_{coll.}(\nu)}$$

ν [Hz]

frequency

f [m]

lens focal length

$FWHM_{spot}(\nu)$ [m]

focus spot diameter

$FWHM_{coll.}(\nu)$ [m]

input beam diameter

Measurement Setup

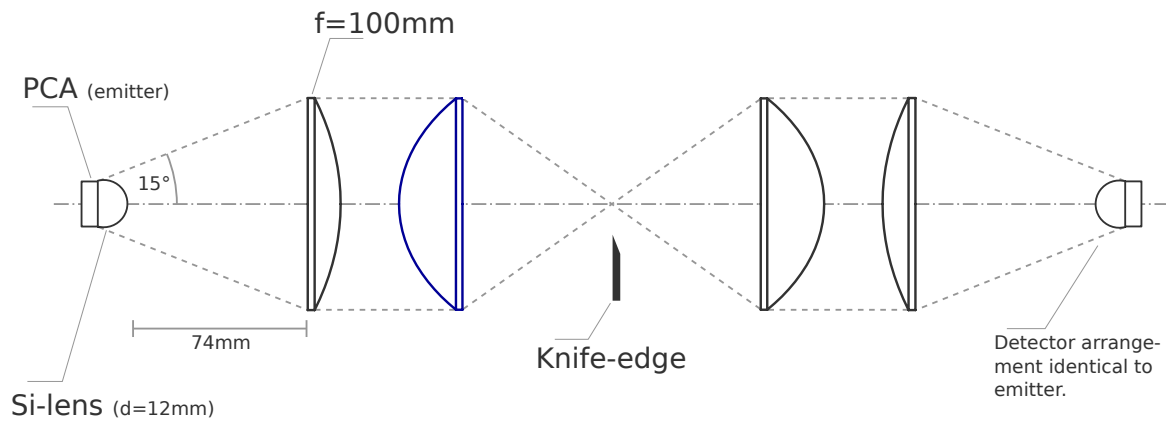

The knife edge setup is sketched in the figure above. Terahertz radiation is generated with a photoconductive antenna (PCA). A hyper hemispherical Si lens followed by a UHMWPE lens collimates the beam. A pair of LU50 lenses are placed in the collimated beam, separated by a distance of 80mm (2x BFL). For detection, an identical lens arrangement as for the collimation then focuses the THz pulse onto a PCA.

To measure the beam profile, a razorblade is moved through the spot with a fixed step size of 0.25mm and at each position, the THz pulse is recorded. The first derivative of the resulting intensity curve at each frequency corresponds to the beam intensity profile.

Additional Information

DAMAGING This PE lens can be scratched by sharp objects.

CONTACT If you have further questions or encounter any problems with our product, please do not hesitate to contact us at:

contact@ame-optics.com